

1.View and size(视图及尺寸)

Main technical indicators(主要技术指标)	
1.Mating (插拔次数)	5000
2.Working Temperature (温度)	-55~+150 °C
3.IP Rating (防护级别)	IP 50
4.Diameter of socket end(插合端直径)	φ1.3
5.Testing Voltage (测试电压)	1850V
6.Working Voltage (工作电压)	1850V
7.Rated Current (额定电流)	15A
8.Shell material(壳体材质)	Brass (chromium-plated) shell and nut/(nickel-plated) lock sleeve and middleware/黄铜(镀铬)外壳和螺母/(镀镍)锁套筒和中间件
9.Pin Material(插针材料)	Copper alloy gold plating(铜合金镀金)
10.Insulator material(绝缘体材质)	PPS

Sum up(总结)	
Series(系列)	B
Shell style/model (外壳样式/型号)	MKG: Fixed receptacle, nut fixing, cable collet(固定插座, 螺母固定, 电缆夹头)
Button (按键)	A button(一个按键)
Termination type (终止类型)	Mother solder tin(母焊锡)
Line diameter awg(线材直径)	28-20AWG
Cable diameterφ (电缆直径)	φ6.3-7.2MM
Match plug(匹配插头)	TGG.2B.P04.CLAD72

Location pin combination(定位销组合)			
(编号) Number	Number of positioning pins(定位销数量)	Angle(角度)	Series(系列)--2B
G	One(1)		(Zero degrees)0°
A	Two(2)	A	Thirty degrees(30°)
B	Two(2)		Forty-five degrees(45°)
C	Two(2)		Sixty degrees(60°)
D	Two(2)	γ	95 degrees (95°)
E	Two(2)	β	120 degrees(120°)
F	Two(2)		145 degrees(145°)
J	Two(2)	A	37.5degrees(37.5°)
K	Two(2)		52.5degrees(52.5°)
L	Two(2)		γ

	A	B	C√	ANGLE	
5-10	±0.02	±0.05	±0.1	0°-30°	±0.1°
50-100	±0.1	±0.15	±0.2	61°-90°	±0.5°
50-100	±0.15	±0.2	±0.25		
100-	±0.15%	±0.20%	±0.25%		

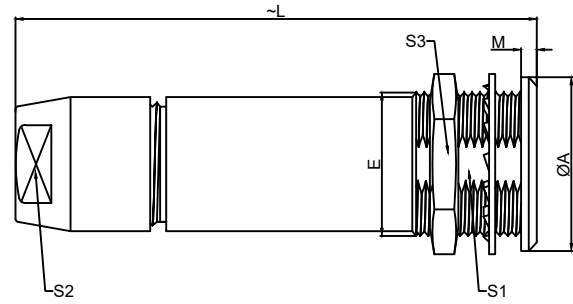

	φA	e	L	M	S1	S2	S3
MM	φ18	M15*1	47.0	1.8	13.5	12.0	17.0
in	0.7087	0.0000	1.8504	0.0709	0.5315	0.4725	0.6693

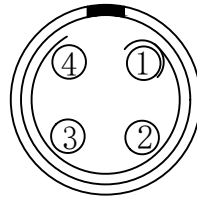

Welded surface (焊接面)

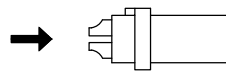

(Welded mother adhesive core) 焊接型母胶芯

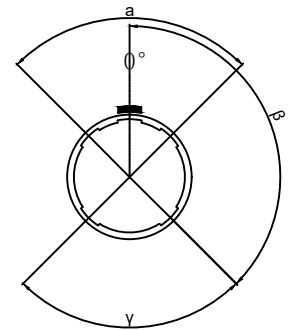

Positive view of the socket (插座正视图)

MK G. 2B. P04.C L L D 72

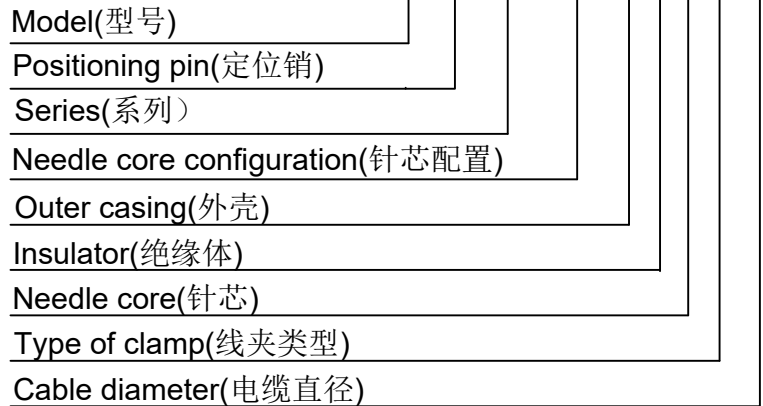

DESIGNED(设计)		DATE(日期)		SCALE(比例)	N/A(不适用)	MODEL TYPE 型号类型: MKG.2B.P04.CLLD72
CHECKED(校对)		DATE(日期)		VIEW(视图)		PART NO. 2B4 core socket 名称: 2B4芯插座
APPROVED(审核)		DATE(日期)		UNIT(单位)	MM	DWG NO.:
REVISIONS				MATERIAL (材料)		
www.helloxkb.com www.helloxkb.cn			XKB INDUSTRIAL PRECISION CO.,LIMITED			WEIGHT(重量) SHEET(表) REVISION(修订)
						1/1 A0